

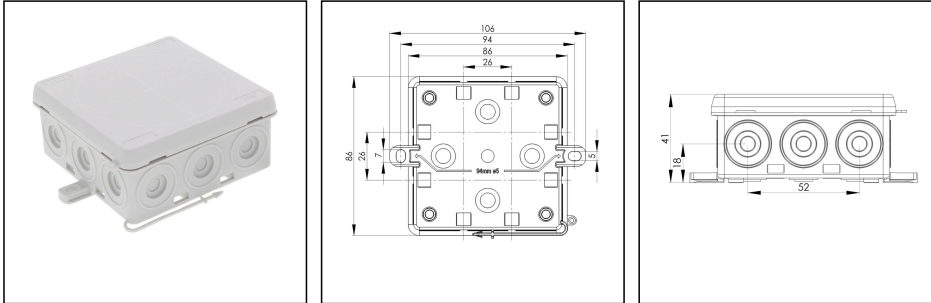

KA 012 LG

Junction box 86x86x41mm, plastic, RAL 7035



Products may differ in size, colour and appearance to those shown. If you require further information or customisation, please contact us directly.



Material	Polyethylene / Polypropylene
Protection class	IP55
Temp. range min	-30 °C
Temp. range max	60 °C
Temperatures during install.	-5 °C - 60 °C
Glow wire test	750 °C
Voltage	400 V
Rated cross section	4 mm ²
Fixing	2 external mounting feet
Ø cable diameter min	7 mm
Ø cable diameter max	12 mm
External dimensions LxWxH	86 x 86 x 41 mm
Using for cable gland	
Product Color	RAL 7035
Order no. RAL 7035	10109427
Type	KA 012 LG
Packing unit	10
ETIM-Classification	EC002600

Remarks:

Fixture: with cable ties, 2 external mounting feet

Equipment: 12 self-sealing, cutable cable entries at the side, 4 on the bottom
captive cover

Recommended accessories

Your Contact:

WISKA Hoppmann GmbH
Kisdorfer Weg 28 · 24568 Kaltenkirchen · Germany
☎ +49-4191-508-0 · 📠 +49-4191-508-209
contact@wiska.de · www.wiska.com

ZER 4-12	10109800
ESD 30	10109875
ESV	10109876
EDV	10109877
SP-KT 11/5 Terminal block	22000409

18.06.2020

Your Contact:

WISKA Hoppmann GmbH

Kisdorfer Weg 28 · 24568 Kaltenkirchen · Germany

☎ +49-4191-508-0 · 📠 +49-4191-508-209

contact@wiska.de · www.wiska.com

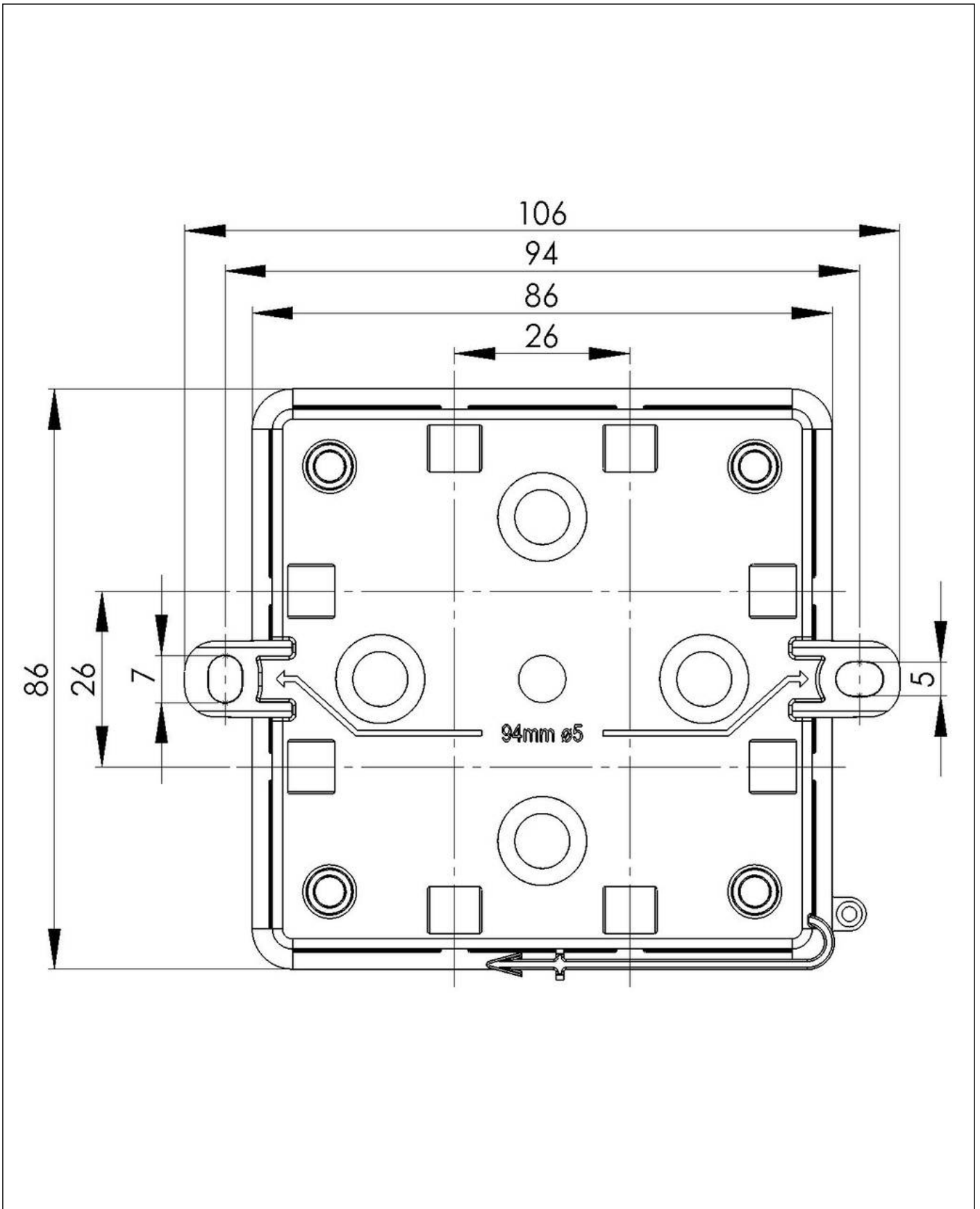

Your Contact:

WISKA Hoppmann GmbH

Kisdorfer Weg 28 · 24568 Kaltenkirchen · Germany

☎ +49-4191-508-0 · 📠 +49-4191-508-209

contact@wiska.de · www.wiska.com

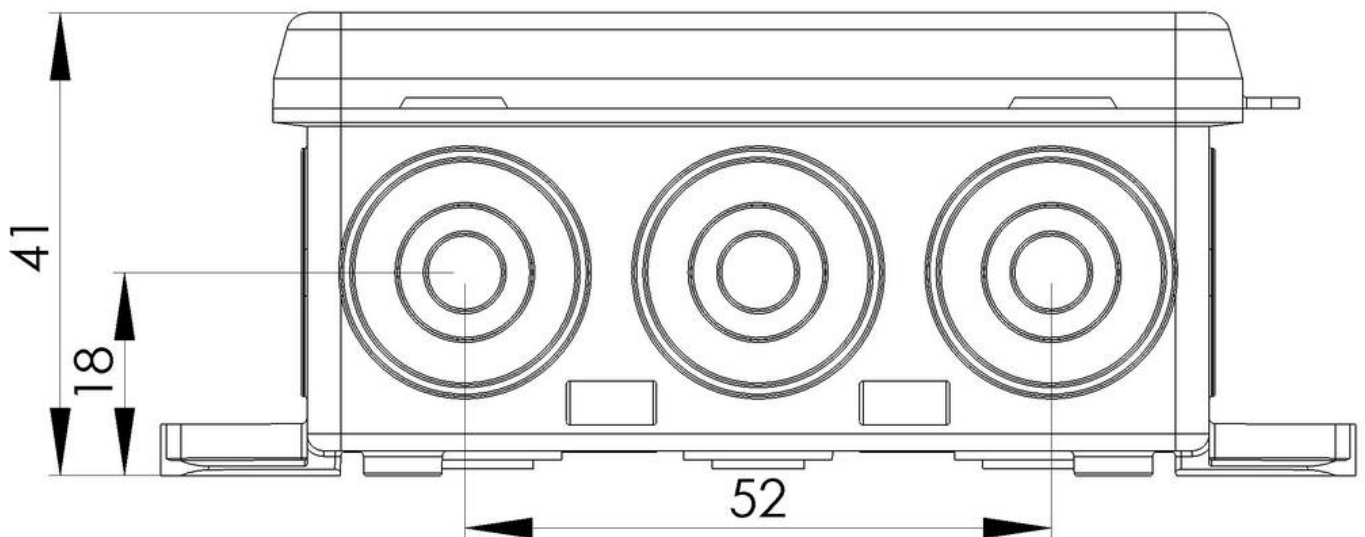

Your Contact:

WISKA Hoppmann GmbH

Kisdorfer Weg 28 · 24568 Kaltenkirchen · Germany

☎ +49-4191-508-0 · 📠 +49-4191-508-209

contact@wiska.de · www.wiska.com