

# VERSASPOT

modulo cablato compatto | compact powerdock

SCHEDA TECNICA | DATA SHEET

ED.06\_27.03.2024

# VERSASPOT

modulo cablato compatto | compact powerdock

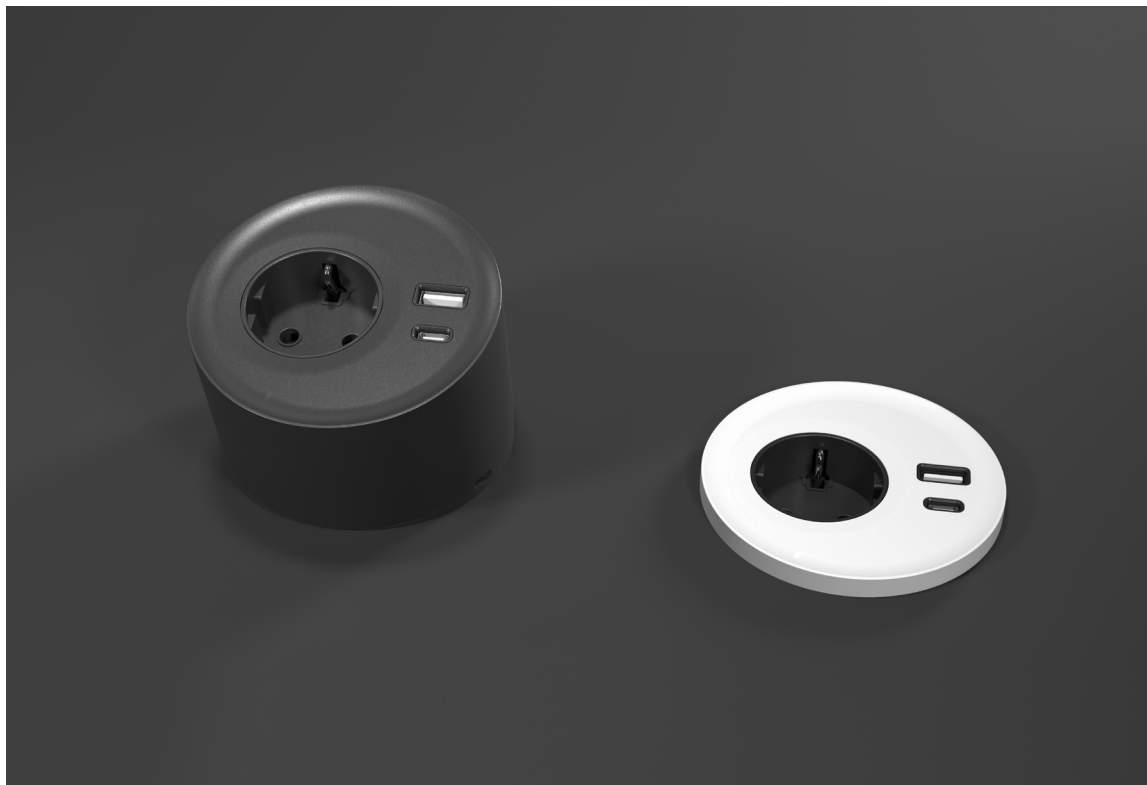

## DATI COMMERCIALI | COMMERCIAL DATA

Codice prodotto Product code	<b>06045</b> .....	Codice famiglia di prodotto - Valido per tutte le configurazioni Family product code - Valid for all configurations
---------------------------------	--------------------	------------------------------------------------------------------------------------------------------------------------

## DATI TECNICI | TECHNICAL DATA

### GENERALE | GENERAL

Tensione nominale Rated voltage	250 V ac, 50 Hz
Corrente nominale Rated current	10 - 16A
Grado di protezione Degree of protection	IP20
Ambiente di utilizzo Operating environment	Interno Indoor
Materiali Materials	Tecnopolimero autoestinguente Flame retardant polymer

**PRESE ELETTRICHE | ELECTRIC SOCKETS**

E - F - G, 2P+T, con otturatori (protezione bimbi)  
 E - F - G, 2P+T, with shutters(child protection)







Tipo Type			
Voltaggio Rated voltage	250 V ac, 50 Hz	Preso tipo Socket type	E - F - G
Corrente Rated current	16 A	Preso tipo Socket type	E - F - G
Carico massimo complessivo Max.load power	3500W	Preso tipo Socket type	E - F - G

**CARICABATTERIE | BATTERY CHARGER**

	Ingresso: Input:	110 - 240 Vac 50/60 Hz	
USB A+C	Uscita: Output:	USB A+C	USB C: 5V- 12V, P.Max. 18W (ricarica rapida / fast charging) USB A: 5V- 12V, P.Max. 18W (ricarica rapida / fast charging) USB A+ USB C: 5V 3A (1.5+1.5) P.Max. 15W (ricarica normale / standard charging)

**FINITURE | FINISHES**

Mascherine e kit stand alone | Mask and stand alone kit

	Bianco White
	Nero Black
	Grigio Cemento Gray
	Verde foglia Green
	Blu capri Blue
	Rosa mattone Pink
	Terra di Siena White

Soft touch

## CERTIFICAZIONI | APPROVALS



## NOTE | NOTES

- Personalizzabile per tipo di prese e connettori data
- Disponibili a richiesta altre finiture
- Uso solo in ambienti interni

### ATTENZIONE!!!

- Questo apparecchio deve essere collegato a terra
- L'apparecchio deve essere collegato ad una presa principale correttamente installata e provvista di collegamento a terra in accordo alle norme vigenti.
- Se il prodotto viene montato in zone a rischio di contatto con l'acqua, bisogna applicare del silicone o sigillanti simili sul piano dove appoggia la cornice.

- It can be customized according to the type of sockets and data connectors
- Indoor use only
- Other finishes available upon request

### WARNING!!!

- This appliance must be earthed
- This appliance must be connected to a main socket correctly installed and provided with ground connection in accordance with current norms.
- If the product is mounted in areas at risk of contact with water, it is necessary to apply silicone or similar sealants on the panel where the frame stands.

## NOTE | NOTES



RAEE - Rifiuti derivanti da Apparecchiature Elettriche ed Elettroniche. Questi prodotti devono essere riciclati in modo adeguato e non devono essere gettati fra i rifiuti domestici o nei rifiuti municipali indifferenziati.

WEEE - Waste of electric and electronic equipment. These products must be recycled properly and should not be disposed as household waste. Disposal in general household waste is prohibited.

Tutte le dimensioni indicate sono nominali. I disegni e le immagini sono solo a scopo illustrativo. I dettagli del prodotto e le dimensioni sono soggetti a modifiche senza preavviso.

All dimensions quoted are nominal only. Drawings and images are for illustrative purposes only. All product dimensions and specifications are subject to change without notice.

**DIMENSIONI (mm) | DIMENSIONS (mm)**

Spessore piano: min 6 mm | Cut out thickness: min 6 mm

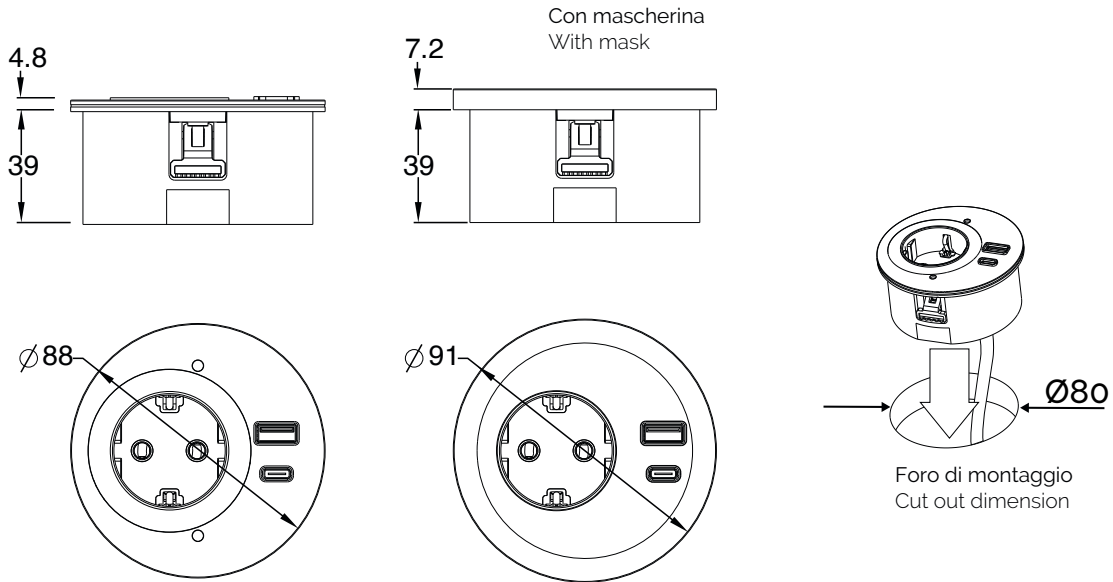

**VERSIONE STANDALONE | STAND ALONE VERSION**

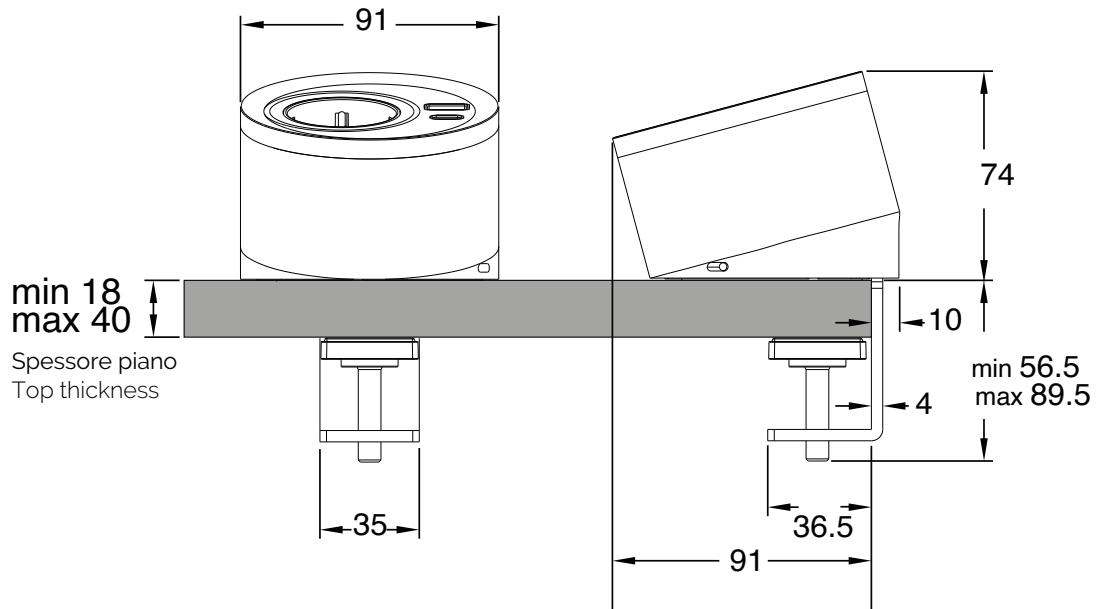









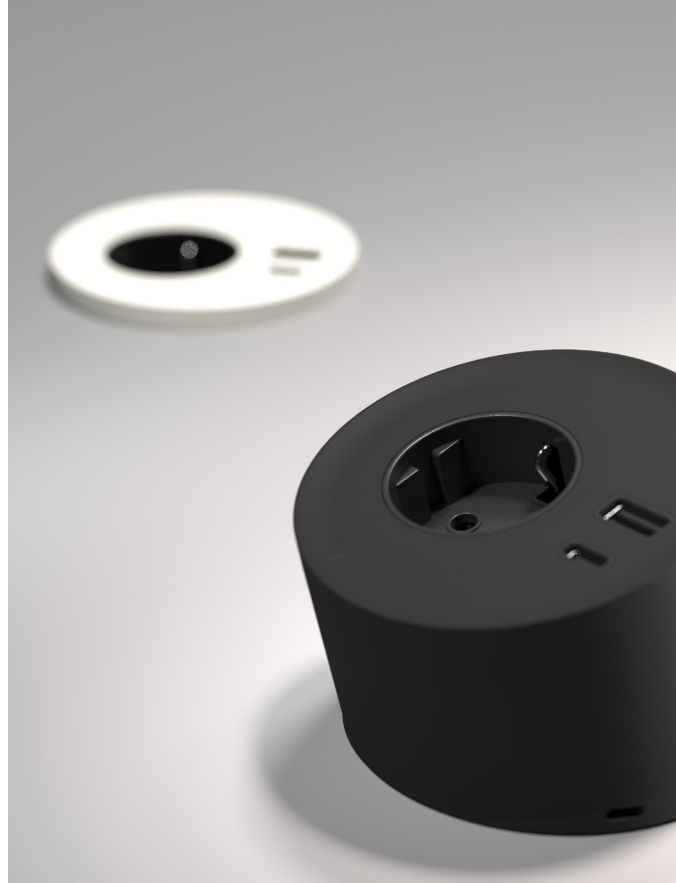



Asa Plastici srl  
via Buonarroti, 58/60  
20090 | Trezzano S/N (MI) | Italy  
Tel/Phone +39 02 4455894 | Fax +39 02 4450107  
web@asaplastici.it  
asaplastici.com

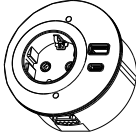

# VERSASPOT



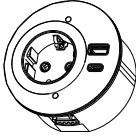







sistema per scrivania  
desk system

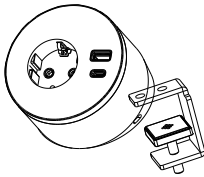

VERSASPOT				
	  F (SCHUKO)	  E (FRENCH)	  G (UK)	
<b>Cavo 2000 mm</b> 2000 mm cable	<b>1 FRUTTO POWER + 1 USB 5V (2 PORTE A+C)</b> 1 POWER SOCKET + 1 USB 5V (2 PORTS A +C)			
nero black	060.45F.00001	060.45E.00001	060.45G.00001	
PREZZO   PRICE				
bianca white	060.45F.00002	060.45E.00002	060.45G.00002	
PREZZO   PRICE				
<b>NOTE   NOTES</b>				
DIM. L x H x W 300 X 196 X 275 mm			PEZZI PER SCATOLA   PCS PER BOX 8	CODICE DOGANALE   CUSTOM CODE 85366990
CAVI INCLUSI   CABLES INCLUDED 2 metri / meters		 	MOQ 8 PZ / PCS	
<b>GST 500 mm</b> GST 500 mm	<b>1 FRUTTO POWER + 1 USB 5V (2 PORTE A+C)</b> 1 POWER SOCKET + 1 USB 5V (2 PORTS A +C)			
nero black	060.45F.00003	060.45E.00003	060.45G.00003	
PREZZO   PRICE				
bianca white	060.45F.00004	060.45E.00004	060.45G.00004	
PREZZO   PRICE				
<b>NOTE   NOTES</b>				
DIM. L x H x W 300 X 196 X 275 mm			PEZZI PER SCATOLA   PCS PER BOX 8	CODICE DOGANALE   CUSTOM CODE 85366990
			MOQ 8 PZ / PCS	
I CAVI DI ALIMENTAZIONE SONO DISPONIBILI NELLA SEZIONE CAVI DEL LISTINO PAG. 112 POWER CABLES ARE LISTED IN THE PRICE LIST CABLE'S SECTION PAG. 112				

VERSASPOT

## VERSASPOT Standalone

	  F (SCHUKO)	  E (FRENCH)	  G (UK)	
<b>Cavo 2000 mm</b> 2000 mm cable	<b>1 FRUTTO POWER + 1 USB 5V (2 PORTE A+C)</b> 1 POWER SOCKET + 1 USB 5V (2 PORTS A +C)			
bianco white	060.45F.00018	060.45E.00018	060.45G.00018	
PREZZO   PRICE				
nero black	060.45F.00017	060.45E.00017	060.45G.00017	
PREZZO   PRICE				
blu capri blue	060.45F.00020	060.45E.00020	060.45G.00020	
PREZZO   PRICE				
rosa mattone pink	060.45F.00023	060.45E.00023	060.45G.00023	
PREZZO   PRICE				
terra di siena yellow	060.45F.00021	060.45E.00021	060.45G.00021	
PREZZO   PRICE				
verde foglia green	060.45F.00019	060.45E.00019	060.45G.00019	
PREZZO   PRICE				
grigio cemento grey	060.45F.00022	060.45E.00022	060.45G.00022	
PREZZO   PRICE				
<b>NOTE   NOTES</b>				
DIM. L x H x W 390 X 280 X 320 mm		PEZZI PER SCATOLA   PCS PER BOX 8	CODICE DOGANALE   CUSTOM CODE 85366990	
CAVI INCLUSI   CABLES INCLUDED 2 metri / meters	 			

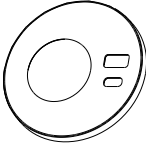
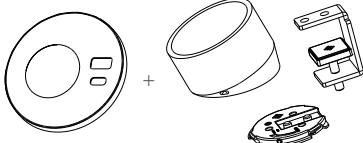
Kit Mascherine / Kit Standalone - Cover Kit / Standalone Kit			
KIT AGGIUNTIVI   CUSTOM KITS			
		MASCHERINA MASK	KIT STAND-ALONE STANDALONE KIT
CODICE CODE	bianco white	590.020.00024	590.020.00029
	PREZZO   PRICE		
	nero black	590.020.00023	590.020.00028
	PREZZO   PRICE		
	blu capri blue	590.020.00026	590.020.00031
	PREZZO   PRICE		
	rosa mattone pink	590.020.00043	590.020.00045
	PREZZO   PRICE		
	terra di siena yellow	590.020.00027	590.020.00032
	PREZZO   PRICE		
	verde foglia green	590.020.00025	590.020.00030
	PREZZO   PRICE		
grigio cemento grey	590.020.00042	590.020.00044	
PREZZO   PRICE			
<b>NOTE   NOTES</b>			
		PEZZI PER SCATOLA   PCS PER BOX 8	CODICE DOGANALE CUSTOM CODE 39269067

VERSASPOT