

## COMBI 607 LG

Junction box 110x110x66mm, polypropylene, RAL 7035

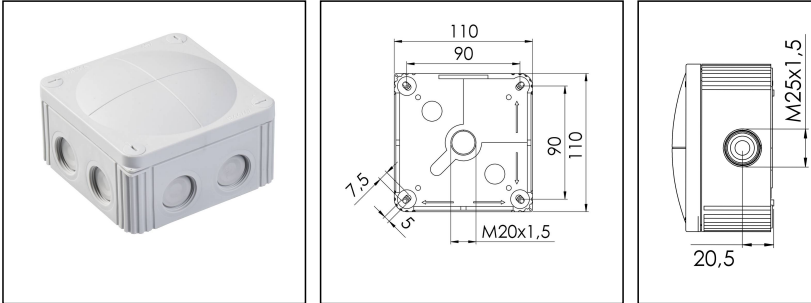

Products may differ in size, colour and appearance to those shown. If you require further information or customisation, please contact us directly.



<b>Material</b>	Polypropylene
<b>Material sealing gasket</b>	TPE
<b>Temp. range min</b>	-30 °C
<b>Temp. range max</b>	100 °C
<b>Temperatures during install.</b>	-5 °C - 60 °C
<b>Protection class</b>	IP66 / IP67
<b>Glow wire test</b>	750 °C
<b>Voltage</b>	690 V
<b>Rated cross section</b>	6 mm <sup>2</sup>
<b>Fixing</b>	4 internal openings
<b>Ø cable diameter min</b>	5,2 mm
<b>Ø cable diameter max</b>	17 mm
<b>External dimensions LxWxH</b>	110 x 110 x 66mm
<b>Using for cable gland</b>	
<b>Product Color</b>	RAL 7035
<b>WISKA-Order no.</b>	10060531
<b>Type</b>	COMBI 607 LG
<b>Packing unit</b>	3
<b>ETIM-Classification</b>	EC002600
<b>EAN number</b>	4007685605311
<b>Tariff number</b>	39269097

Remarks:

IP66: using the membrane entry

IP67: using the threaded entry together with ESKV cable gland

Your Contact:

**WISKA Hoppmann GmbH**

Kisdorfer Weg 28 · 24568 Kaltenkirchen · Germany

☎ +49-4191-508-0 · 📠 +49-4191-508-209

contact@wiska.de · www.wiska.com

**Equipment:**

- 7 M25 threaded membrane entries
- 3 membrane cable entries through rear
- 4 captive cover screws

**Mounting:**

- 4 internal openings outside of the sealing area

**Recommended accessories**

DIN Rail Kit - COMBI 607/TS 35	10060361
MP-L Mounting plate large COMBI / WHK	10105775
External mounting - COMBI LG	10108836
SP-HKT 607 Terminal block	22000407

26.03.2024

**Your Contact:**

**WISKA Hoppmann GmbH**

Kisdorfer Weg 28 · 24568 Kaltenkirchen · Germany

☎ +49-4191-508-0 · 📠 +49-4191-508-209

contact@wiska.de · www.wiska.com

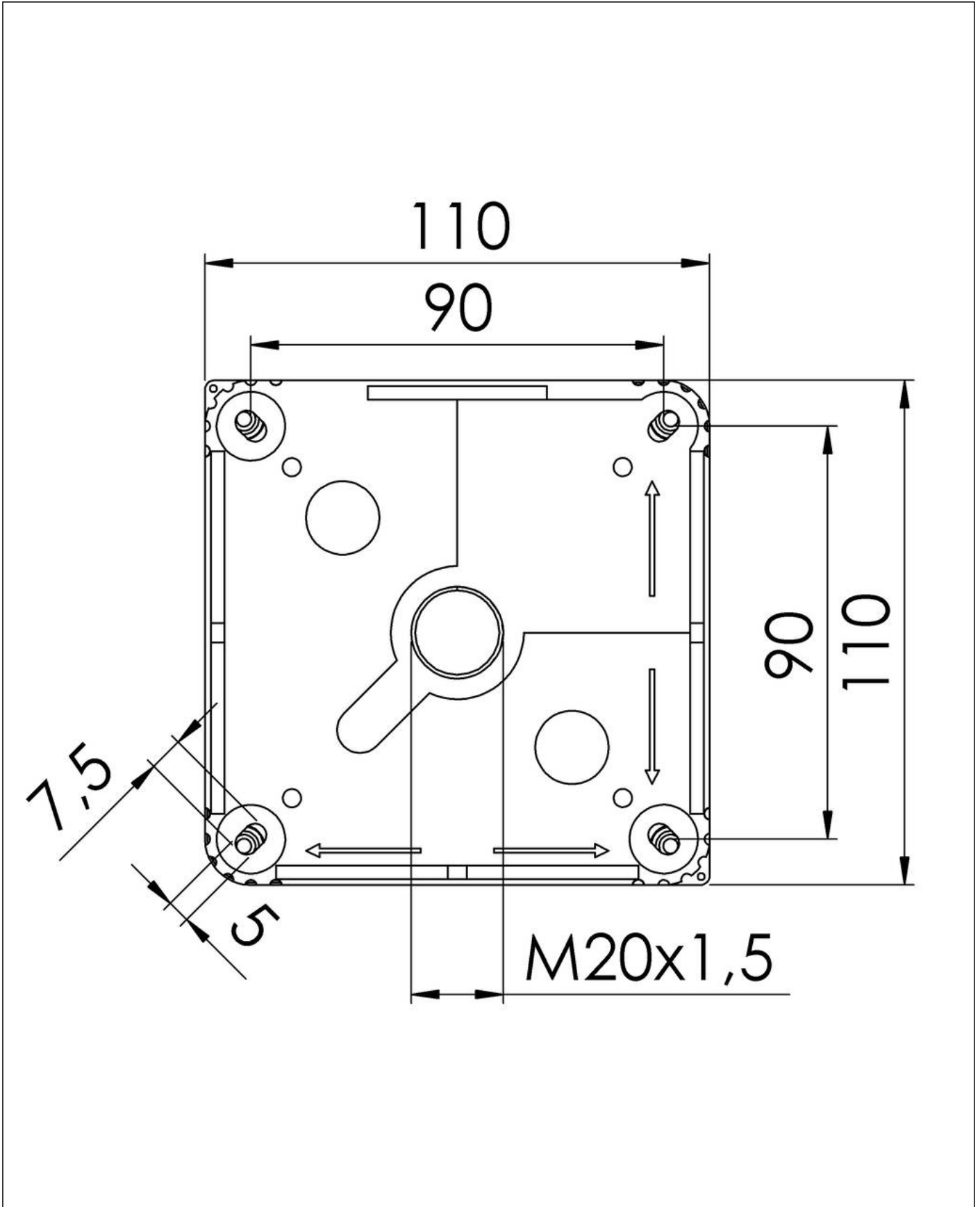

Your Contact:

**WISKA Hoppmann GmbH**

Kisdorfer Weg 28 · 24568 Kaltenkirchen · Germany

☎ +49-4191-508-0 · 📠 +49-4191-508-209

contact@wiska.de · www.wiska.com

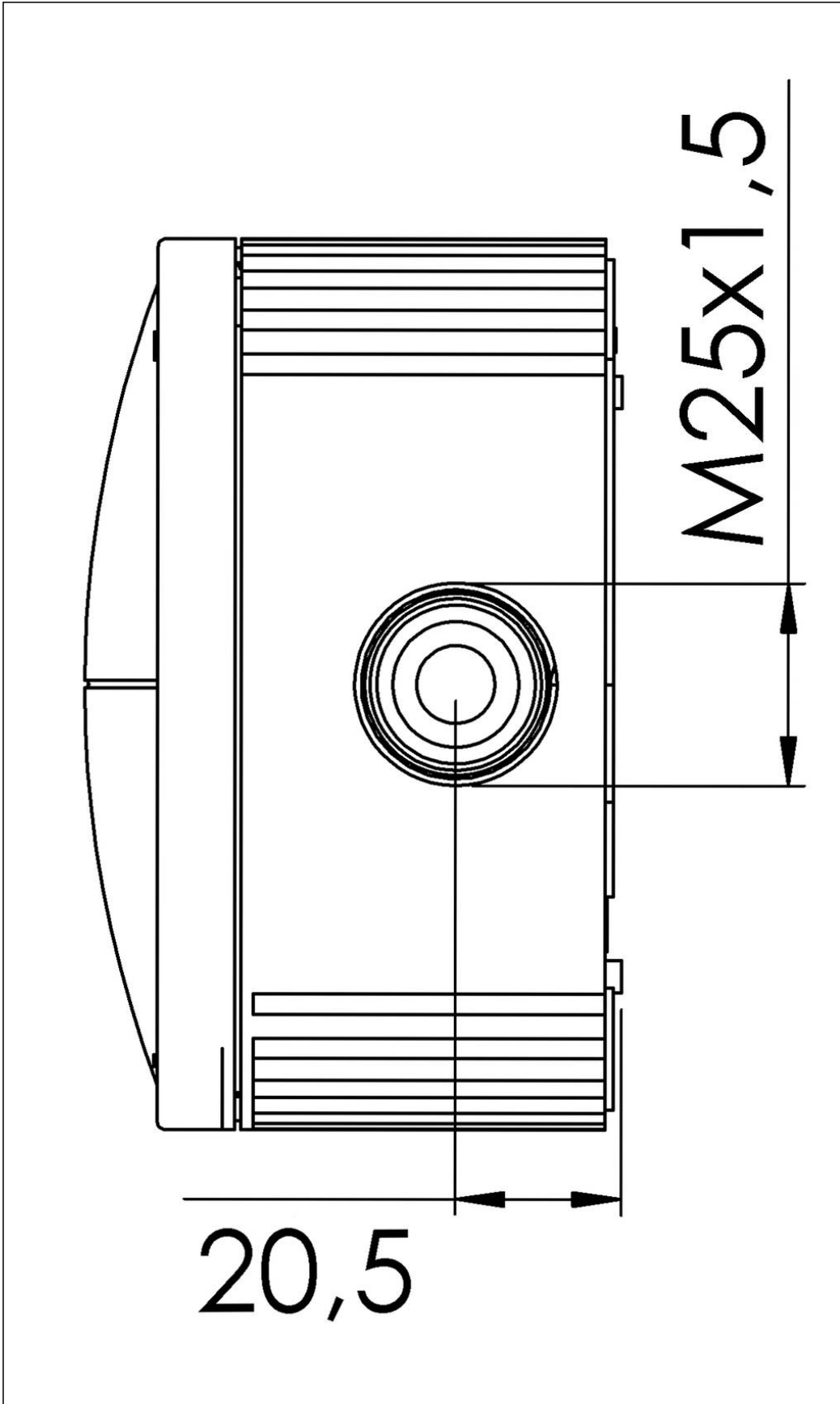

Your Contact:

**WISKA Hoppmann GmbH**

Kisdorfer Weg 28 · 24568 Kaltenkirchen · Germany

☎ +49-4191-508-0 · 📠 +49-4191-508-209

contact@wiska.de · www.wiska.com