

EMSKV 16 EMV-Z

EMC-cable gland, brass with short thread

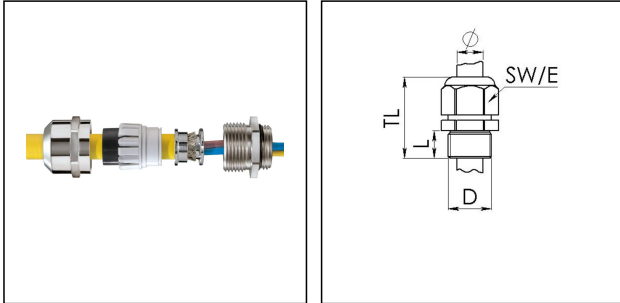

Products may differ in size, colour and appearance to those shown. If you require further information or customisation, please contact us directly.



Material cable gland	Brass nickel-plated
Material sealing gasket	EPDM
Material clamping cage	Polyamide
Material earthing insert	Brass chromium-plated
Temp. range min	-40 °C
Temp. range max	100 °C
Protection class	IP69, IP68 (5 bar 30 min)
Thread type	M
Ø Connection thread D	16
Lead	1,5
Length screw-in thread L	5 mm
Ø cable diameter min	4,5 mm
Ø cable diameter max	10 mm
Ø cable below cable shield max	7,5 mm
Key width SW	20 mm
Collar diameter (E)	22 mm
Total length TL	26 mm - 34 mm
Type of cable anchorage	A
Install. torques cap nut	4 N m
Install. torques fitting	4 N m
Impact category	6
Surface	Nickel-plated
Order no. nickel-plated	10065017
Type	EMSKV 16 EMV-Z
Packing unit	50

Your Contact:

WISKA Hoppmann GmbH

Kisdorfer Weg 28 · 24568 Kaltenkirchen · Germany

☎ +49-4191-508-0 · 📠 +49-4191-508-209

contact@wiska.de · www.wiska.com

Tariff number	85369010
EAN number	4007685650175
ETIM-Classification	EC000441

Recommended accessories

RDE 16	10062184
EMMU-EMV 16	10063211
BS 10	10064008

24.10.2023

Your Contact:

WISKA Hoppmann GmbH

Kisdorfer Weg 28 · 24568 Kaltenkirchen · Germany

☎ +49-4191-508-0 · 📠 +49-4191-508-209

contact@wiska.de · www.wiska.com



Your Contact:

WISKA Hoppmann GmbH

Kisdorfer Weg 28 · 24568 Kaltenkirchen · Germany

☎ +49-4191-508-0 · 📠 +49-4191-508-209

contact@wiska.de · www.wiska.com